

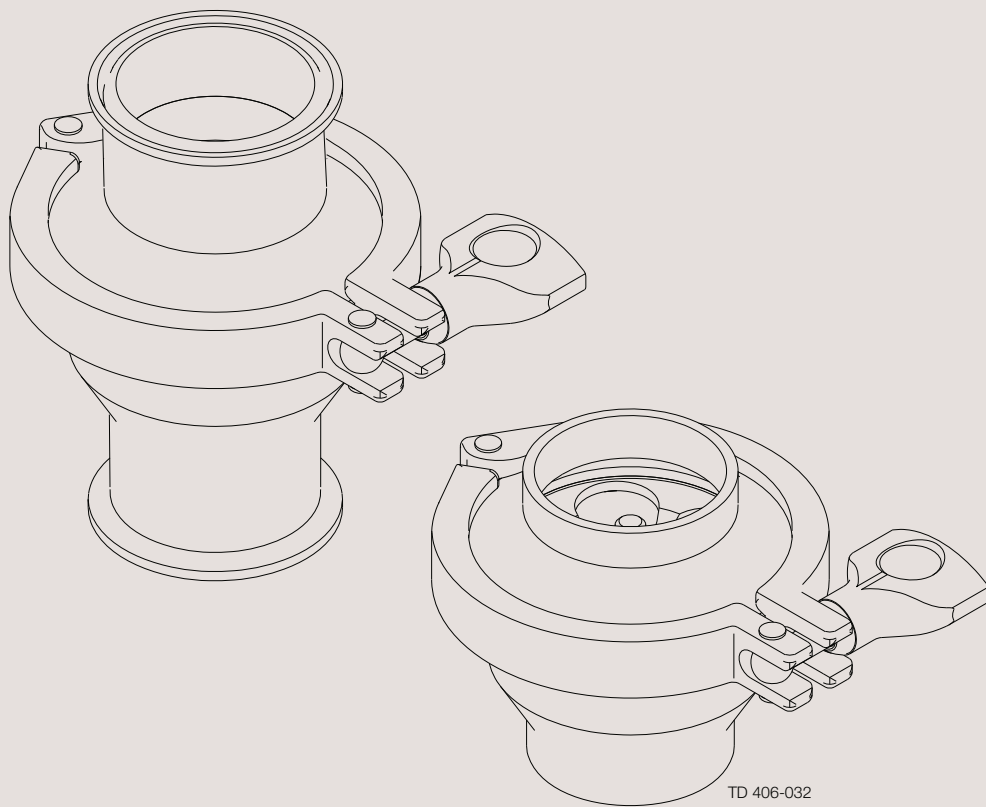

Spare Parts

LKC UltraPure, non-return Valve



ESE00841-EN3 2017-11

Original manual

Table of contents

The information herein is correct at the time of issue but may be subject to change without prior notice

1. LKC UltraPure, ISO	4
2. LKC UltraPure, DIN	6

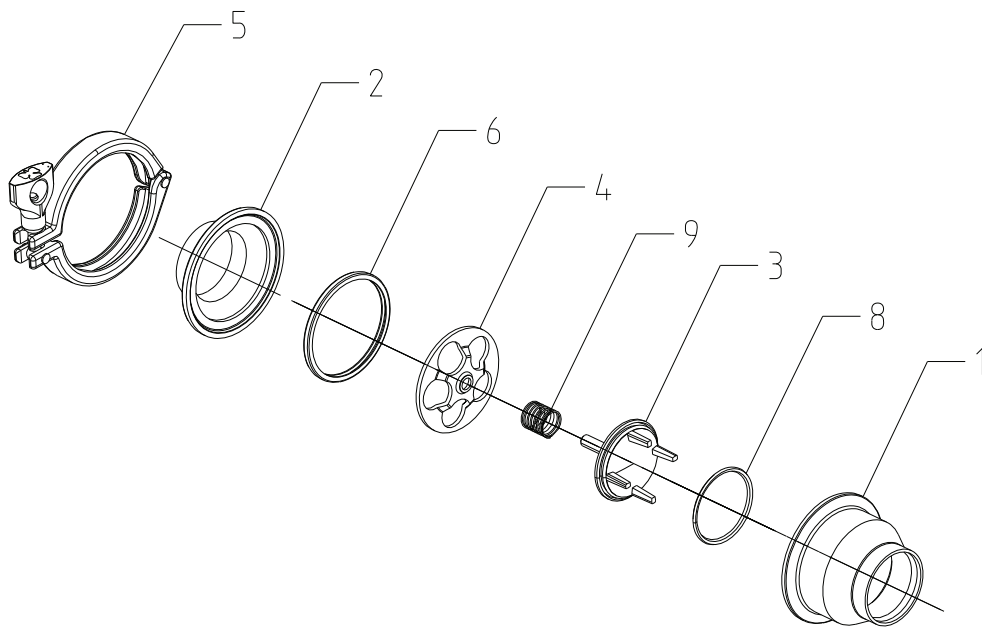

TD 406-030

Pos	Qty	Denomination	DN/OD 25	DN/OD 38	DN/OD 51	DN/OD 63.5	DN/OD 76.1	DN/OD 101.6
1	1	Valve body, welding ends						
2	1	Welding liner, welding ends						
3	1	Valve cone	9612220713	9612220714	9612220715	9612220716	9612220717	9612220718
4	1	Guide plate	9612370913	9612370914	9612370915	9612370916	9612370917	9612370918
5	1	Clamp ring	211054	211055	211056	211057	270267	9611311057
6	<input type="checkbox"/>	1 Seal ring, EPDM						
	1	Seal ring, FPM						
8	<input type="checkbox"/>	1 O-ring, EPDM						
	1	O-ring, FPM						
9	<input type="checkbox"/>	1 Spring						
			DN/OD 25	DN/OD 38	DN/OD 51	DN/OD 63.5	DN/OD 76.1	DN/OD 101.6

Service kits for product wetted parts

<input type="checkbox"/>	Service kit EPDM	9611924202	9611924203	9611924204	9611924205	9611924206	9611924207
<input type="checkbox"/>	Service kit FPM	9611924280	9611924281	9611924282	9611924283	9611924284	9611924285

Parts marked with are included in service kits.

Recommended spare parts: Service kits.

TD900700/1

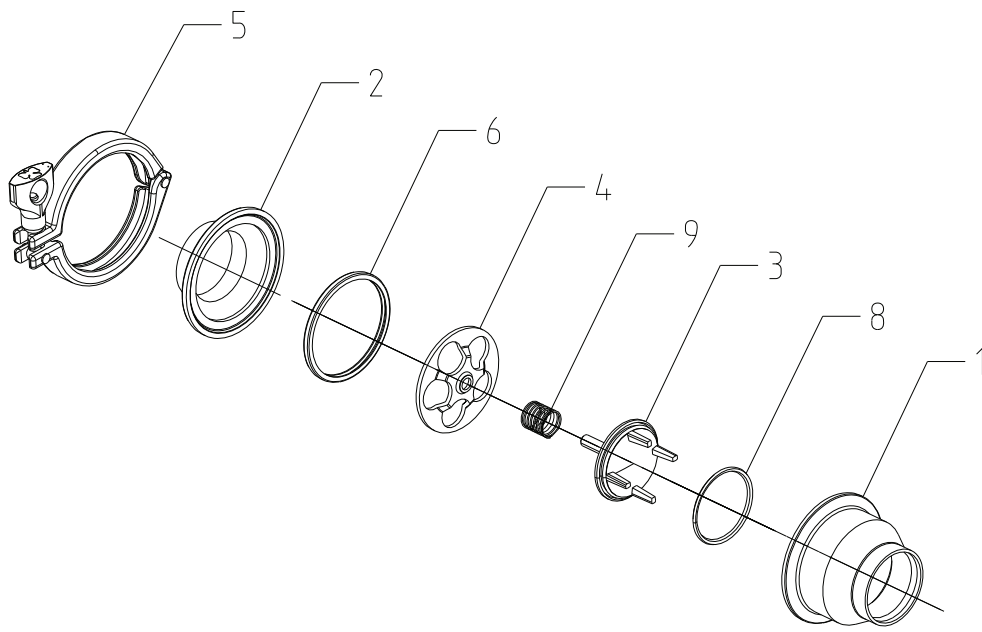

TD 406-030

Pos	Qty	Denomination	DN 25	DN 32	DN 40
1	1	Valve body, welding ends			
2	1	Welding liner, welding ends			
3	1	Valve cone	9612220713	9612220714	9612220714
4	1	Guide plate	9612370913	9612370914	9612370914
5	1	Clamp ring	211054	211055	211055
6	<input type="checkbox"/>	Seal ring, EPDM			
	1	Seal ring, FPM			
8	<input type="checkbox"/>	O-ring, EPDM			
	1	O-ring, FPM			
9	<input type="checkbox"/>	Spring			

Pos	Qty	Denomination	DN 50	DN 65	DN 80	DN 100
1	1	Valve body, welding ends				
2	1	Welding liner, welding ends				
3	1	Valve cone	9612220715	9612220716	9612220717	9612220718
4	1	Guide plate	9612370915	9612370916	9612370917	9612370918
5	1	Clamp ring	211056	211057	270267	9611311057
6	<input type="checkbox"/>	Seal ring, EPDM				
	1	Seal ring, FPM				
8	<input type="checkbox"/>	O-ring, EPDM				
	1	O-ring, FPM				
9	<input type="checkbox"/>	Spring				

DN 25 DN 32 DN 40

Service kits for product wetted parts

<input type="checkbox"/>	Service kit EPDM	9611924202	9611924203	9611924203
<input type="checkbox"/>	Service kit FPM	9611924280	9611924281	9611924281

DN 50 DN 65 DN 80 DN 100

Service kits for product wetted parts

<input type="checkbox"/>	Service kit EPDM	9611924204	9611924205	9611924206	9611924207
<input type="checkbox"/>	Service kit FPM	9611924282	9611924283	9611924284	9611924285

Parts marked with are included in the service kits.

Recommended spare parts: Service kits.

How to contact Alfa Laval

Contact details for all countries are continually updated on our website.

Please visit www.alfalaval.com to access the information directly.

© Alfa Laval Corporate AB

This document and its contents is owned by Alfa Laval Corporate AB and protected by laws governing intellectual property and thereto related rights. It is the responsibility of the user of this document to comply with all applicable intellectual property laws. Without limiting any rights related to this document, no part of this document may be copied, reproduced or transmitted in any form or by any means (electronic, mechanical, photocopying, recording, or otherwise), or for any purpose, without the expressed permission of Alfa Laval Corporate AB. Alfa Laval Corporate AB will enforce its rights related to this document to the fullest extent of the law, including the seeking of criminal prosecution.